

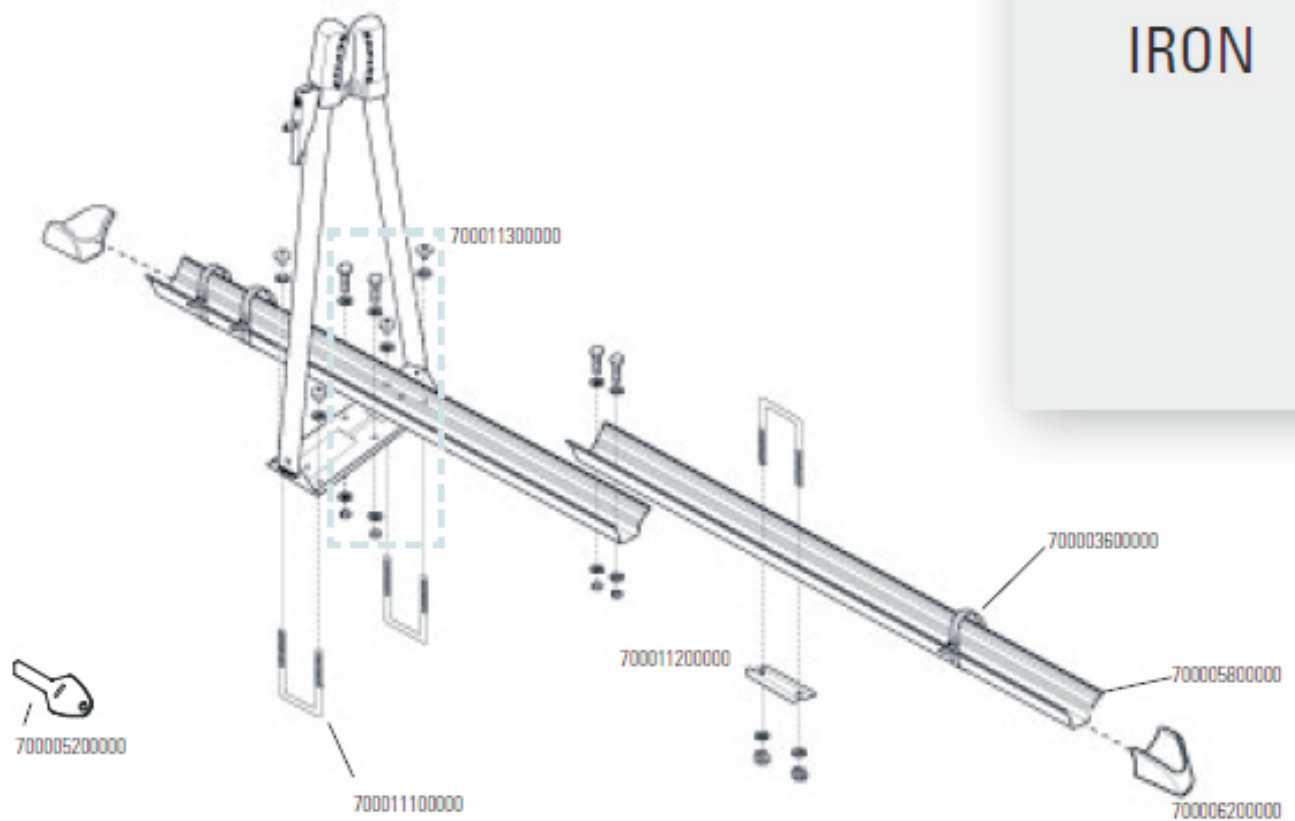











# IRON



N.	Q.ty	Spare Parts (Made to order)	Code
2	2		70000580000
3	2		70000620000
4	1		70001120000
5	3	<b>M 6x14</b> 	70001110000
6	3		70000360000

N.	Q.ty	Spare Parts (Made to order)	Code
7	4	<b>M6x14</b> 	70001130000
8	2	 <b>6x18</b>	
9	4		
10	4	 <b>M6</b>	
11	12	<b>6x12</b> 	
12	1	 <b>XXXX</b>	70000520000