

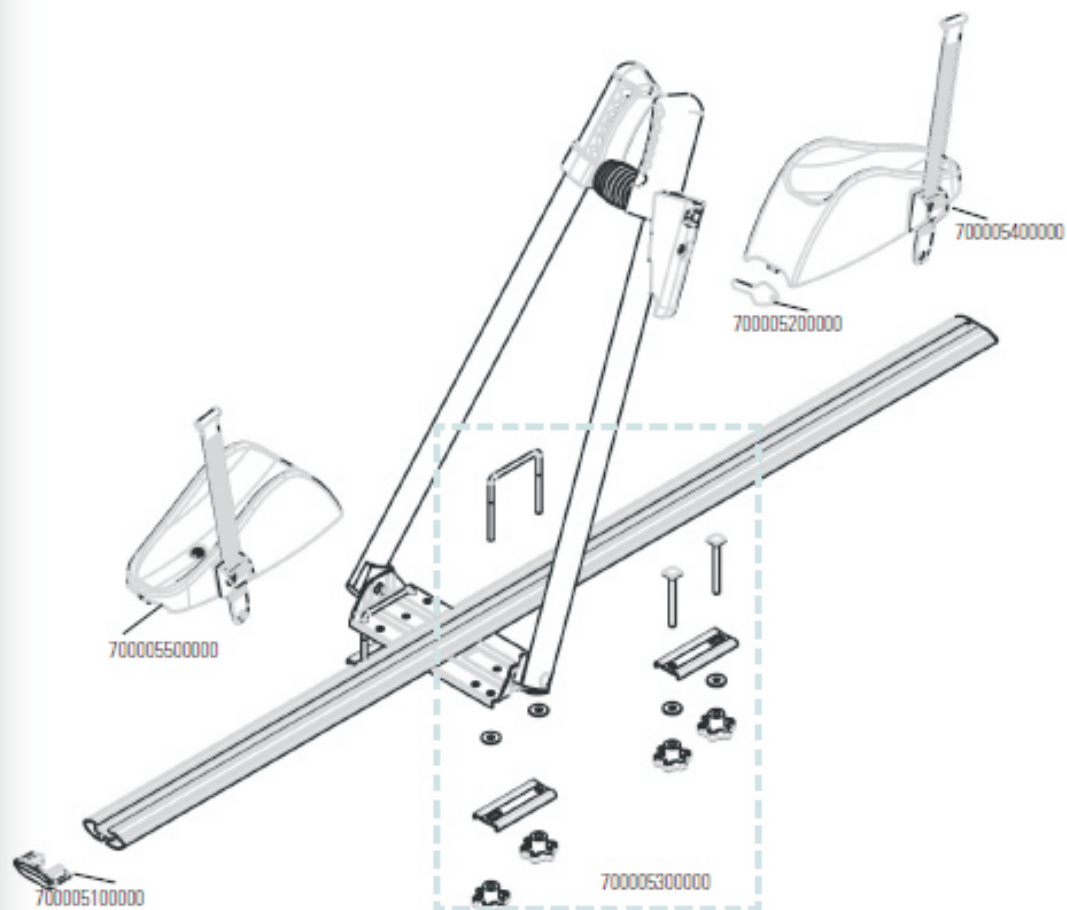









ASSO



N.	Q.ty	Spare Parts (Made to order)		Code
2	1		 DX	700005400000
3	1	 SX		700005500000
4	2			700005300000
5	3			
6	6			
7	6			
8	2			
9	2			
10	1		 XXXX	700005200000